

製品引き出し方向
PRODUCT WITHDRAWAL DIRECTION

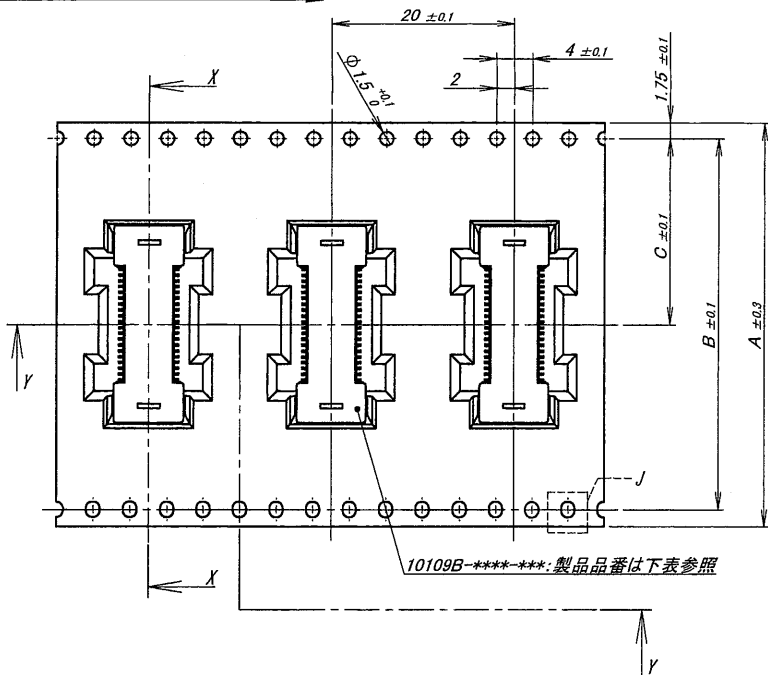

10109B-***-***: 製品品番は下表参照

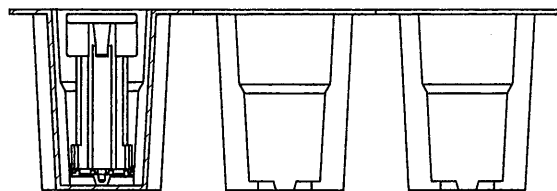

SECT. Y-Y

梱包品番 PACKING No.	製品品番 PRODUCTS No.	ボス/BOSS
10109B-***Y926	10109B-***R-GN	有/WITH
10109B-***Y927	10109B-***S-GN	無/WITHOUT
10109B-***Y932	10109B-***R-GFN1	有/WITH
10109B-***Y933	10109B-***S-GFN1	無/WITHOUT

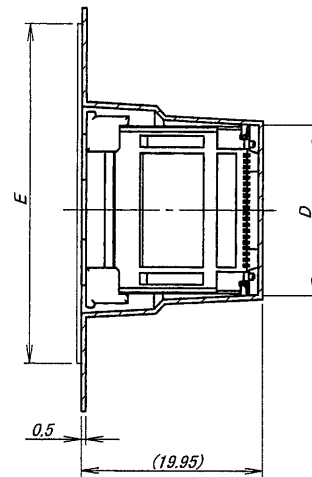

SECT. X-X

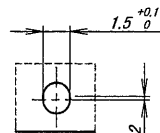

DETAIL J

梱包番号 PACKING No.	A	B	C	D	E	M	対応 /HANDLING
10109B-30Y9**	32,000	28,400	14,200	18,700	26,000	80,000	○
10109B-40Y9**				21,875			
10109B-50Y9**	44,000	40,400	20,200	25,050	37,000		○
10109B-60Y9**				29,225			
10109B-70Y9**				31,400			
10109B-80Y9**	56,000	52,400	26,200	34,575	49,000		
10109B-90Y9**				37,750			
10109B-100Y9**				40,925			
10109B-110Y9**	72,000	68,400	34,200	44,100	65,000	100,000	
10109B-120Y9**				47,275			

NOTE

1. 梱包数量 / UNIT QUANTITY : 200 PIECES / REEL
2. リードテープ長さ / LEAD TAPE LENGTH

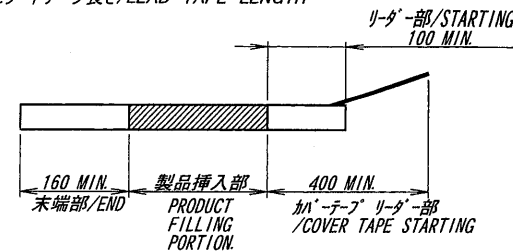

3. カバーテープの剥離強度 / COVER TAPE PEELING FORCE 0.2~1.3N (剥離方向は、下図参照 / PEELING DIRECTION AS BELOW)

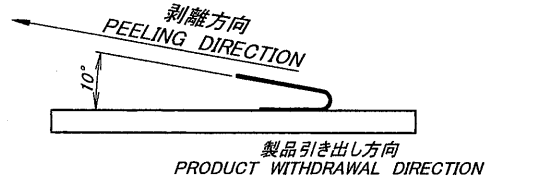

製品引き出し方向
PRODUCT WITHDRAWAL DIRECTION

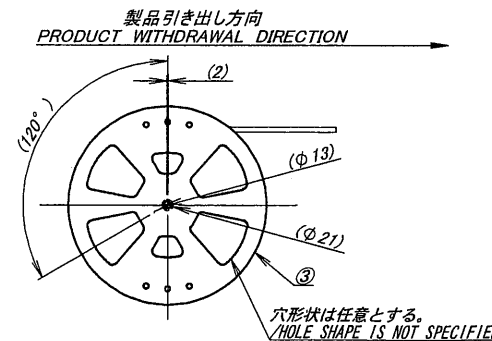
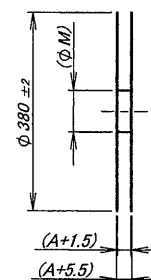

MATERIAL 材質

- ①カバーテープ : PET TYPE
- ②キャリアテープ : PS (透明)
- ③リール : PS (黒)
- ④COVER TAPE : PET TYPE
- ⑤CARRIER TAPE : PS (CLEAR)
- ⑥REEL : PS (BLACK)

FINISH 仕上げ

GENERAL TOLERANCES 一般公差

DIM 寸法 ± 0.3
ANGLE 角度 ±

3RD. ANG. PROJ. 三角法

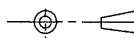

SCALE 尺度

単位 mm

DR

'15/3/2

CHK

'15/3/3

UNIT 単位

mm

DSN

'14/6/18

APP

'15-3-3

TITLE 名称

10109 シリーズ プラグ エンボス 梱包品
SERIES 10109 PLUG EMBOSS PRODUCT

EDP No

PARTS No 部番

IMS A-10109B-***Y9** (926, 927, 932, 933)

DWG No 図番

120-210109-009

REV.

1

