

A B C D E F G H

製品引き出し方向  
PRODUCT  
WITHDRAWAL DIRECTION →

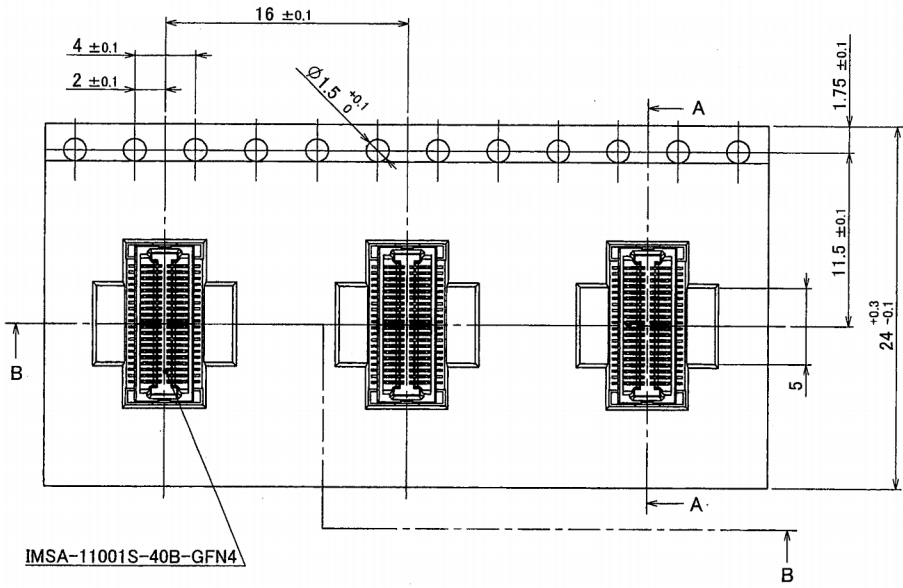

MSA-11001S-40B-GFN4

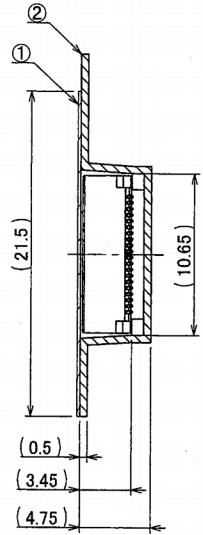

SECT.A-A

NOTE  
1.梱包数量/UNIT QUANTITY: 1000 PIECES/REEL  
2.リードテープ長さ/LEAD TAPE LENGTH

製品引き出し方向  
PRODUCT WITHDRAWAL DIRECTION →

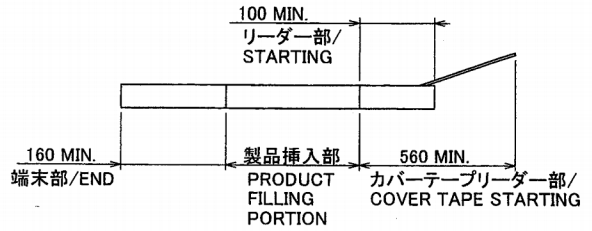

3.カバーテープの剥離強度 : 0.2~1.3N  
COVER TAPE PEELING FORCE : 0.2~1.3N

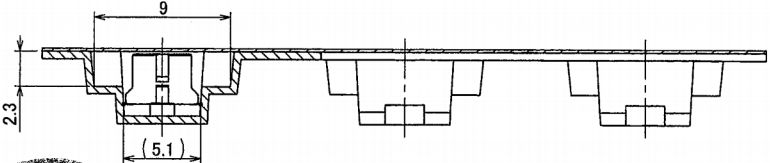
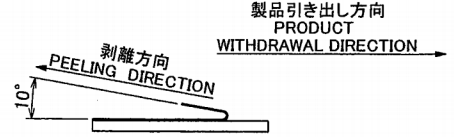

SECT.B-B

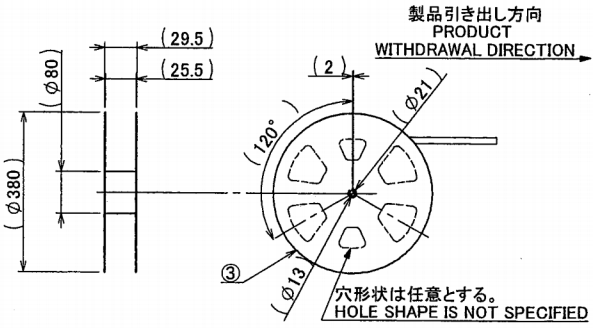

製品引き出し方向  
PRODUCT  
WITHDRAWAL DIRECTION →

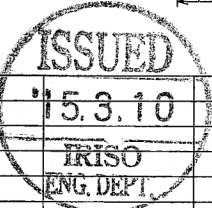

<p>△ 15.3.10</p> <p>IRISO ENG. DEPT.</p>		<p>MATERIAL 材質</p> <p>①カバーテープ/COVER TAPE : PET TYPE ②キャリアテープ/CARRIER TAPE : PS(CLEAR) ③リール/REEL : PS(BLACK)</p>		<p>GENERAL TOLERANCES 一般公差</p> <p>DIM 寸法 ± 0.3 ANGLE 角度 ± —</p>		<p>SCALE 尺度 /</p> <p>DR '15/03/06 M. Hasegawa CHK '15 3/6 J. Sakine</p>		<p>UNIT 単位 mm</p> <p>DSN '14/5/27 D. Furuyama APP '15-3-6</p>		<p>TITLE 名称 0.4mmピッチ/PITCH 11001シリーズ ソケット エンボス 梱包品 SERIES 11001 SOCKET EMBOSS PRODUCT</p>	
<p>△ 49409 RELEASED N.H. T.S. '15.03.06</p> <p>△ SKETCHED D.F. S.M. '14.5.27</p>		<p>FINISH 仕上げ</p>		<p>3RD. ANG. PROJ. 三角法</p>		<p>IRISO ELECTRONICS CO., LTD イリソ電子工業株式会社</p>		<p>EDP No</p>		<p>PARTS No 部番 MSA-11001S-40Y900</p>	
<p>ECN No REVISION RECORD 記 事</p>		<p>DR CHK DATE 年月日</p>		<p>DWG No 図番 120-111001-001</p>		<p>REV. 1</p>					

DO NOT SCALE DRAWING. THIS DRAWING CONTAINS INFORMATION THAT IS PROPRIETARY TO IRISO AND SHOULD NOT BE USED WITHOUT WRITTEN PERMISSION. 本図面は、イリソ電子工業(株)の所有する情報を含むもので当社の許可なく複製を禁止する。

REDUCED COPY