

極数	部品番号	A	B	C	D
CKT	PARTS No.				
08	9261B-2-08Y936	14.3	11.5	24.0	21.5

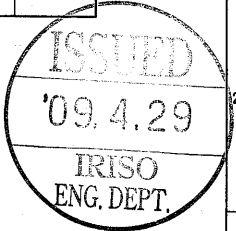

NOTE

1. 梱包数量: 1000ヶ/リール
2. リードテープ長さ: 下図参照

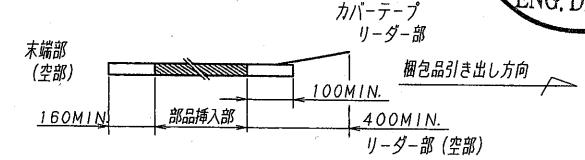

3. カバーテープの剥離強度: (剥離方向は、下図参照のこと。) 0.2~1.3N 尚、本規格値は、製造時に適用。

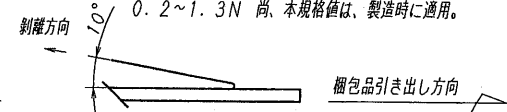

NOTE:

1. UNIT QUANTITY: 1000 PCS/REEL
2. LEAD TAPE LENGTH: SEE CHART BELOW

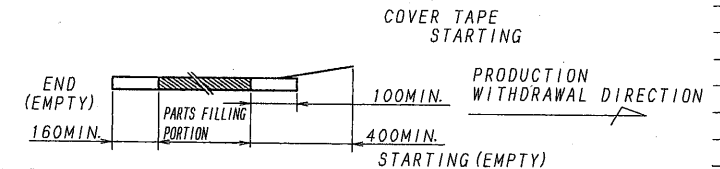

3. COVER TAPE PEELING FORCE (PEELING DIRECTION AS BELOW) 0.2~1.3N FOR MANUFACTURING

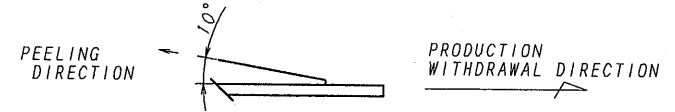

9261B-2-**Z029-PT1

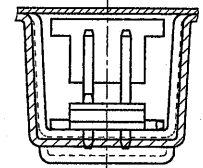

SECT. G-G

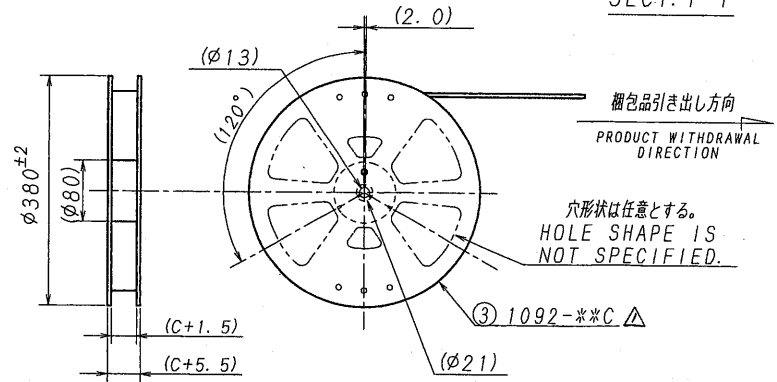

SECT. F-F

△						
△						
△						
△						
△						
△						
△						
△	REVISED	Y.T	M.T	08-12-2		
LTR	ECN NO.	REVISION RECORD	DR	CHK	DATE	
記号		記			年月日	

MATERIAL 材質	① キャリアテープ/CARRIER TAPE: PS △ ② カバーテープ/COVER TAPE: PET-TYPE ③ リール/REEL: PS (黒/BLACK) △
FINISH 仕上り	

GENERAL TOLERANCES 一般公差	DIM 寸法 ± 0.3 ANGLE 角度 ±
3RD. ANG. PROJ. 三角法	

SCALE 尺度 /	UNIT 単位 mm
DR 08-12-2 Y. Takeuchi	DSN 03-7-24 Kashiro
CHK 08-12-2 M. TAKAGI	APP 12/08 F. Naga
IRISO ELECTRONICS CO., LTD. IRISO 電子工業株式会社	

TITLE 名称	9261シリーズ コネクタ エンボス 梱包品 SERIES 9261 EMBOSS TAPING PRODUCT	
EDP No		
PARTS No 部番	9261B-2-**Y936	
DWG No 図番	IMSA-9261B-2-**Y936	
REV.	/	