

A B C D E F G H

仕様

- ※印部は、根元管理とする。
- 本製品は、錫系のめっきを施しておりますので、ウイスキーが発生する可能性がございます。その為、ウイスキー発生に対する保証は困難であり、御社にて御判断の上御使用をお願いします。
- 本製品は錆の発生を通常品よりも抑制する効果を持たせた製品ですが、錆の発生を無くす事を保証する製品ではありません。

NOTE

- ※ : AT BOTTOM
- THIS PRODUCT UTILIZES LEAD-FREE TIN PLATING. ANY PRODUCT WITH LEAD-FREE TIN PLATING IS SUSCEPTIBLE TO TIN WHISKER. IRISO PROVIDES NO ASSURANCES AGAINST THE GROWTH OF TIN WHISKER EVEN UNDER NORMAL OPERATING CONDITIONS. CUSTOMERS ASSUME ALL RESPONSIBILITY FOR ANY PRODUCT FAILURES DUE SOLELY TO THE GROWTH OF TIN WHISKERS
- APPLICABLE PRODUCT HAS EFFECT TO SUPPRESS THE OCCURRENCE OF RUST. HOWEVER, IT IS NOT A PRODUCTION THAT GUARANTEES THAT THERE IS NO OCCURRENCE OF RUST.

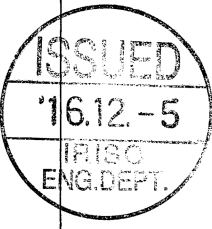
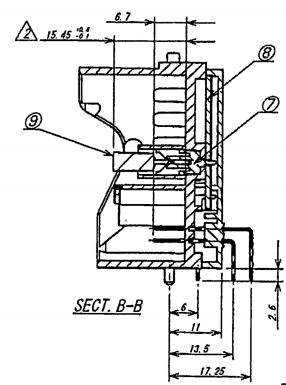
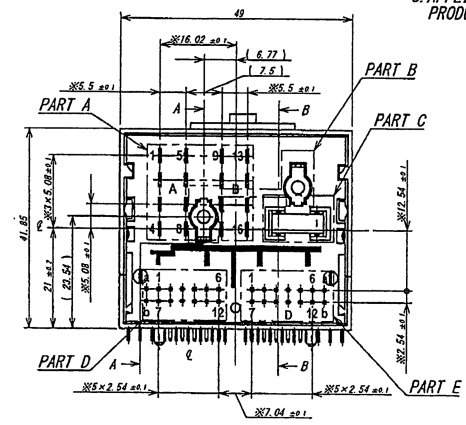
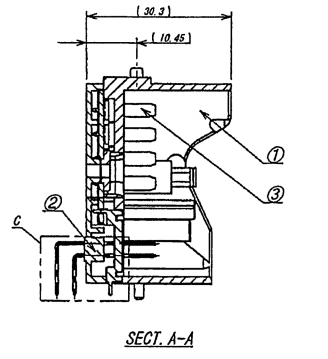
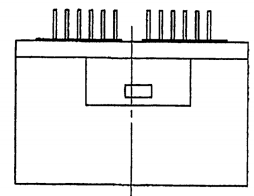
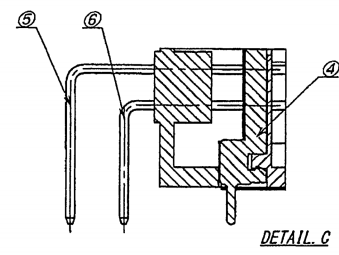

POST																FLANGE		FUSE CONTACT	
PART A																PART B		PART C	
1	2	3	4	5	6	7	8	9	10	11	12	13	14	15	16	1	2	1	2
○	○	○	○	○	○	○	○	○	○	○	○	○	○	○	○	○	○	○	○

PIN												PIN															
PART D												PART E															
a	1	2	3	4	5	6	7	8	9	10	11	12	b	a	1	2	3	4	5	6	7	8	9	10	11	12	b
○	○	○	○	○	○	○	○	○	○	○	○	○	○	○	○	○	○	○	○	○	○	○	○	○	○	○	

PCB POST																	
PART F																	
1	2	3	4	5	6	7	8	9	10	11	12	13	14	15	16	17	18
○	○	○	○	○	○	○	○	○	○	○	○	○	○	○	○	○	○

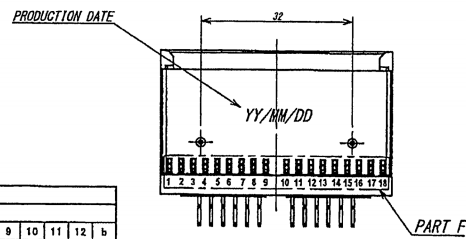

製品番号/PART NO.	ヒューズ仕様/FUSE
9472-60Z53-TM2	10A
9472-60Z54-TM2	15A

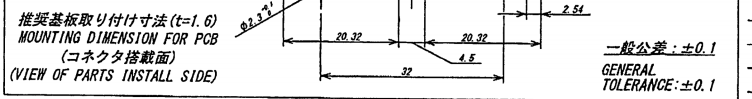

MATERIAL 材質						GENERAL TOLERANCES 一般公差		SCALE 尺度		UNIT 単位		TITLE 名称	
△						DIM 寸法 ± 0.3		/		mm		9472シリーズ ピンヘッダー SERIES 9472 PIN HEADER	
△						ANGLE 角度 ±		DR 2016-11-25 Shenghu		DSN 2013-6-17 Shenghui		EDP No	
△						3RD. ANG. PROJ. 三角法		CHK 16-11-30 Shenghu		APP 16-11-30 Shenghui		PARTS No 部番	
△	5651	DIM REV	He	Sheng	16-11-25							IRISO ELECTRONICS CO., LTD イリス電子工業株式会社	
△	49418	RELEASED	Ji	Sheng	'15-3-6							IMS-A-9472B-60Z53/Z54-TM2	
△	-	SKETCHED	Ji	Sheng	'15-1-8							DWG No 図番	
LTR	ECN No	REVISION RECORD	DR	CHK	DATE							REV. 2	

DO NOT SCALE DRAWING. THIS DRAWING CONTAINS INFORMATION THAT IS PROPRIETARY TO IRISO AND SHOULD NOT BE USED WITHOUT WRITTEN PERMISSION. 本図面は、イリス電子工業(株)の所有する情報を含むもので当社の許可なく複製を禁ずる。