

種別/CKT	製品番号/PARTS No.	A	B	C	D	E	F
40	9637S-40Y801	21.1	24.4	40.4	44.0	20.2	37.0
41	-41	21.6	24.9				
42	-42	22.1	25.4				
43	-43	22.6	25.9				
44	-44	23.1	26.4				
45	-45	23.6	26.9				
46	-46	24.1	27.4				
47	-47	24.6	27.9				
48	-48	25.1	28.4				
49	-49	25.6	28.9				
50	-50	26.1	29.4				
51	-51	26.6	29.9				
52	-52	27.1	30.4				
53	-53	27.6	30.9				
54	-54	28.1	31.4				
55	-55	28.6	31.9				
56	-56	29.1	32.4				
57	-57	29.6	32.9				
58	-58	30.1	33.4				
59	-59	30.6	33.9				
60	9637S-60Y801	31.1	34.4	52.4	56.0	26.2	49.0

NOTE

1. 梱包数量/UNIT QUANTITY: 2000 PIECES/REEL
2. リードテープ長さ/LEAD TAPE LENGTH

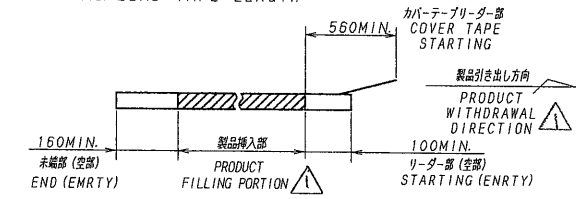

3. カバーテープの剥離強度: (剥離方向は、下図参照のこと)  
0.2~1.3N 尚、本規格値は、製造時に適用。  
COVER TAPE PEELING FORCE  
(PEELING DIRECTION AS BELOW)  
0.2~1.3N FOR MANUFACTURING.

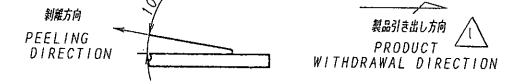

4. テープ幅24mm以下の場合、シングルキャリアとする (図参照)。  
TAPE WIDTH UNDER 24mm: SINGLE CARRIER.  
(A DRAWING REFERENCE)

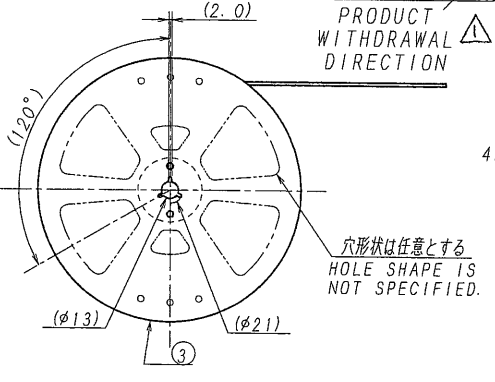
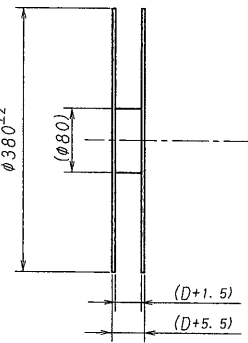
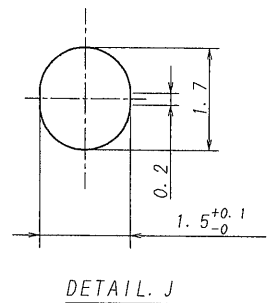
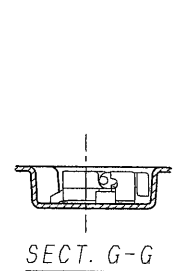
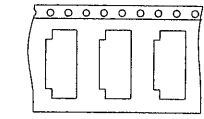

ISSUED  
73.6.-3  
IRISO  
ENG. DEPT.

△							
△							
△							
△							
△	44149	NOTE REV	D.K	K.K	'13-5-30		
△	42072	RELEASED	T.H	S.S	'12-6-5		
LTR	BCN NO	REVISION RECORD	DR	CHK	DATE		
記号		号			年月日		

MATERIAL 材質	① カバ-テープ/COVER TAPE: PET TYPE ② キャリアテープ/CARRIER TAPE: A-PET ③ リール/REEL: PS (黒/BLACK)
FINISH 仕上げ	

GENERAL TOLERANCES 一般公差	SCALE 尺度 /	UNIT 単位 mm
DIM 寸法 ± 0.3	DR '13-5-30	DSN '02-12-20
ANGLE 角度 ±	D. Kim	Matsu
	CHK 15	APP 73
	S30 K. Kobayashi	S30 M. Takagi
3RD. ANG. PROJ. 三角法	IRISO ELECTRONICS CO., LTD.	
	IRISO 電子工業株式会社	

TITLE 名称	9637シリーズ FPC/FFC エンボス梱包品
	SERIES 9637 FFC/FPC EMBOSS PRODUCT
EDP No	
PARTS No 部番	1MSA-9637S-**Y801
DWG No 図番	120-109637-004
REV.	1