

A B C D E F G H

引き出し方向/WITHDRAWAL DIRECTION →

極数/CKT	部番/Parts No.	A	B	C	D	E	F	G	COVER TAPE	ET-REEL
15	9691S-15Y901	10	15.6	18.9	14.2	28.4	32	26	1011-260C	1092-36C

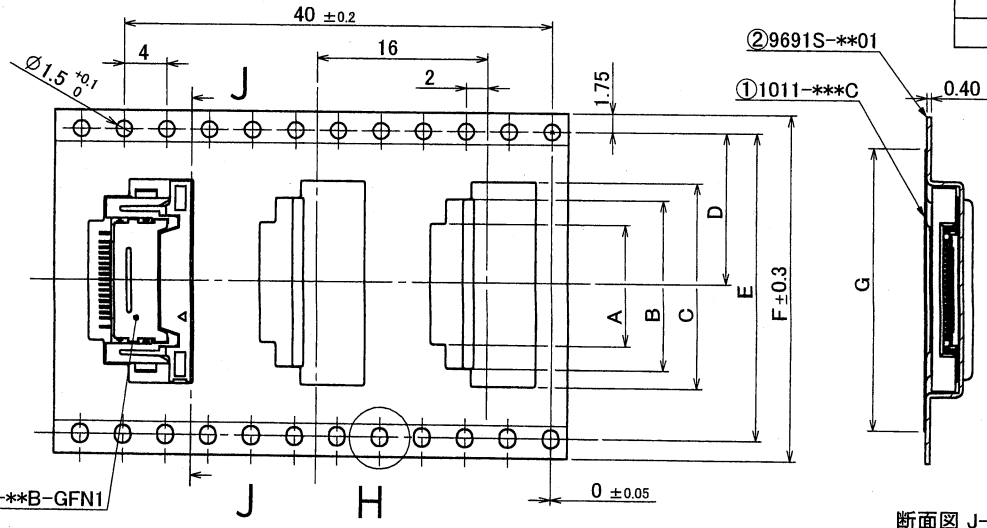

断面図 J-J

- 1. 梱包数量/UNIT QUANTITY: 1400 PIECES/REEL
- 2. リードテープ長さ/LEAD TAPE LENGTH

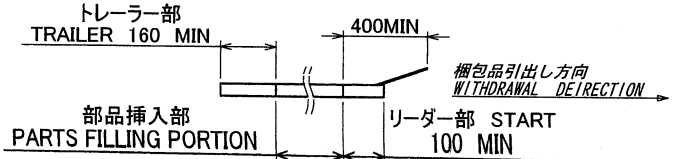

- 3. カバーテープの剥離強度/COVER TAPE PEELING FORCE: 0.2~1.3N (剥離方向は、下図参照/PEELING DIRECTION AS BELOW)

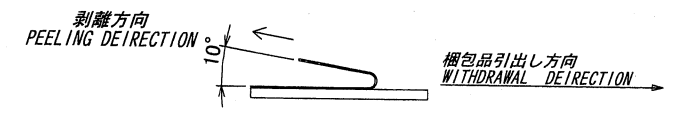

- 4. 梱包方法は、KS-0002Z参照のこと。REFER TO KS-0002Z FOR THE PACKING METHOD.

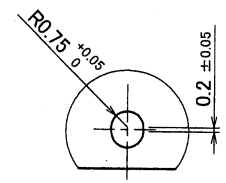
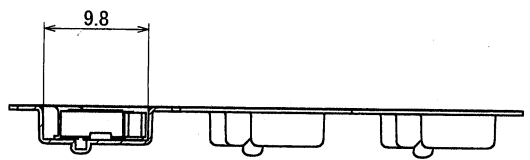

詳細 H
スケール 4:1

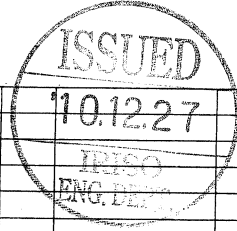
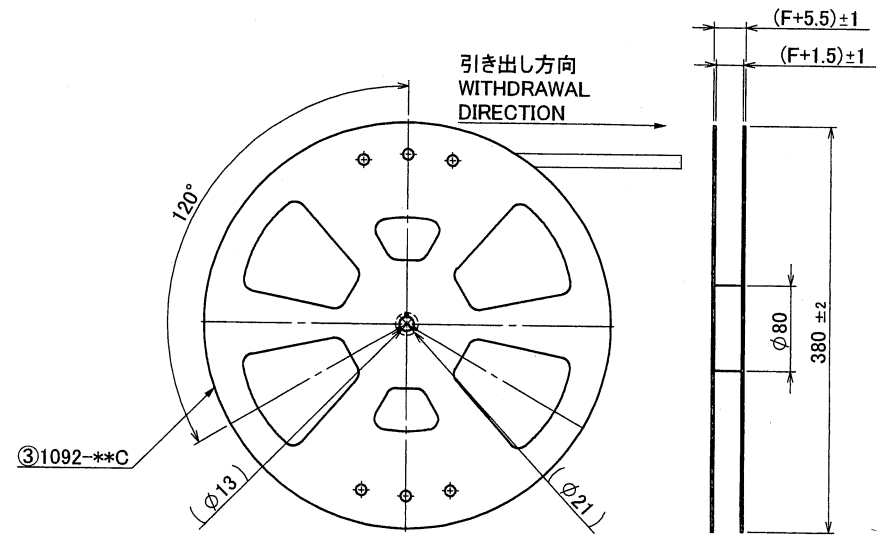

△ △ △ △ △ △ △ △ △ △ △	10.12.27					MATERIAL 材質	GENERAL TOLERANCES 一般公差	SCALE 尺度	UNIT 単位	TITLE 名称
	IRISO ENG. DEPT.					①カバーテープ/COVER TAPE : PET ②キャリアテープ/CARRIER TAPE : PS ③リール/REEL : PS 黒/BLACK	DIM 寸法 ± 0.1 ANGLE 角度 ± 2	DR 10-12-23 M. Takami	DSN 109-6-4 M. Takaki	9691シリーズ エンボス梱包品
FINISH 仕上げ						3RD. ANG. PROJ. 三角法	CHK 10 M. TAKA	APP 10-12-24 C. Nakahara	EDP No	
							IRISO ELECTRONICS CO., LTD イリス電子工業株式会社		PARTS No 部番	
3D643	REVISID	M. T	MT	10-12-23			9691S-**Y901		REV.	
記号	ECN No	REVISION RECORD 記	DR	CHK	DATE 年月日			DWG No 図番		2