

A B C D E F G H

製品引き出し方向
PRODUCT WITHDRAWAL DIRECTION

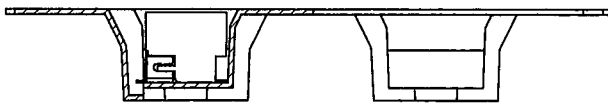

SECT. X-X

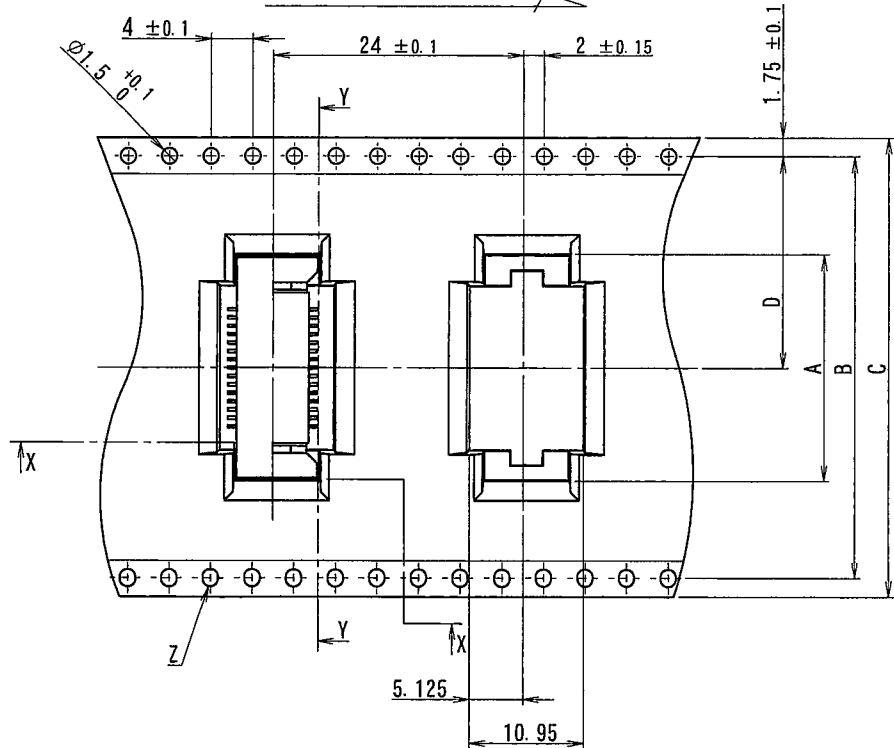
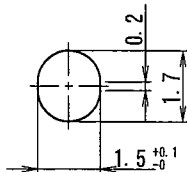

DETAIL Z

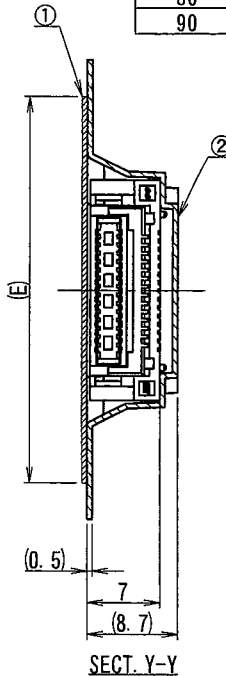

SECT. Y-Y

極数/CKT	製品番号	A	B	C	D	E	F
30	9828B-30Y9**	21.4	40.4	44.0	20.2	37.0	80.0
40	-40	25.4					
50	-50	29.4					
60	-60	33.4					
70	-70	37.4					
80	-80	41.4	68.4	72.0	34.2	65.0	100.0
90	9828B-90Y9**	45.4					

梱包品番	製品番号	ボス
PACKING No.	PARTS No.	BOSS
9828B-**Y926	9828B-**S-GF1	ボスあり/WITH BOSS
9828B-**Y927	9828B-**T-GF1	ボス無し/WITHOUT BOSS

NOTE

1. 梱包数量/UNIT QUANTITY:300
2. リドテープ長さ/LEAD TAPE LENGTH

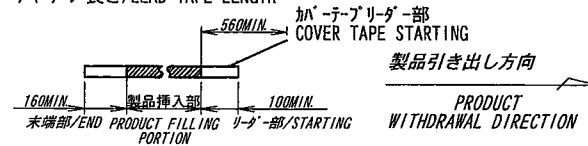

3. カバーテープの剥離強度/COVER TAPE PEELING FORCE : 0.2N~1.3N

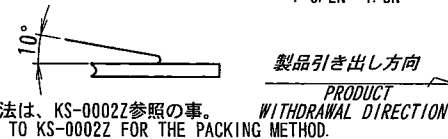

4. 梱包方法は、KS-0002Z参照の事。/REFER TO KS-0002Z FOR THE PACKING METHOD.

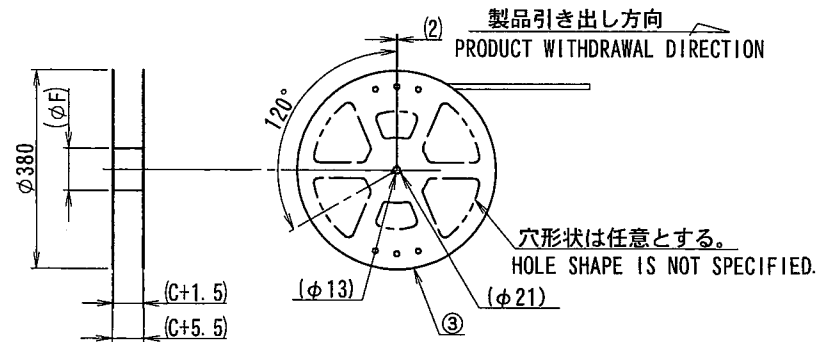

ISSUED
'14.3.19

IRISO
ENG. DEPT.

△					MATERIAL 材質	GENERAL TOLERANCES 一般公差	SCALE 尺度	UNIT 単位	TITLE 名称
△					①カバーテープ/COVER TAPE : PET TYPE	DIM 寸法 ± 0.3	DR '14/03/14	mm	9828 シリーズ プラグ エンボス梱包品
△					②キャリアテープ/CARRIER TAPE : PS	ANGLE 角度 ±	J. Nakayama	DSN '12/03/15	SERIES 9828 PLUG EMBOSS PRODUCT
△					③リール/REEL : PS (黒/BLACK)		K. Sato	EDP No	
△	43833	NOTE REV	T. N	'14-3-14	FINISH 仕上げ	3RD. ANG. PROJ. 三角法	CHK	APP	PARTS No 部番
△	42123	REVISED	D. K	'13-9-15			3/14 '14		IMS A-9828B-**Y9** (Y926, Y927)
△		REVISED	T. A	'12-8-28					DWG No 図番
△		REVISED	L. Q	'12-6-12					120-209828-004
△	ECN No	REVISION RECORD	DR	CHK	DATE				REV. 5

DO NOT SCALE DRAWING. THIS DRAWING CONTAINS INFORMATION THAT IS PROPRIETARY TO IRISO AND SHOULD NOT BE USED WITHOUT WRITTEN PERMISSION. 本図面は、イリソ電子工業(株)の所有する情報を含むもので当社の許可なく複製を禁止する。

REDUSED COPY