

極数/CKT	製品番号/PARTS No.	A	B	C	D	E	F	G
6	9852S-06Y946	7.2	8.8					
8	9852S-08Y946	9.2	10.8	11.5		21.5	24	2.0 ± 0.1
10	9852S-10Y946	11.2	12.8					
12	9852S-12Y946	13.2	14.8	14.2	28.4	26	32	
14	9852S-14Y946	15.2	16.8					
16	9852S-16Y946	17.2	18.8					2.0 ± 0.15
18	9852S-18Y946	19.2	20.8					
20	9852S-20Y946	21.2	22.8	20.2	40.4	37	44	
22	9852S-22Y946	23.2	24.8					
24	9852S-24Y946	25.2	26.8					
26	9852S-26Y946	27.2	28.8					
28	9852S-28Y946	29.2	30.8	26.2	52.4	49	56	
30	9852S-30Y946	31.2	32.8					

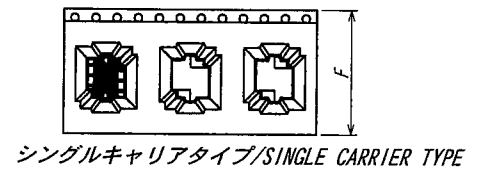
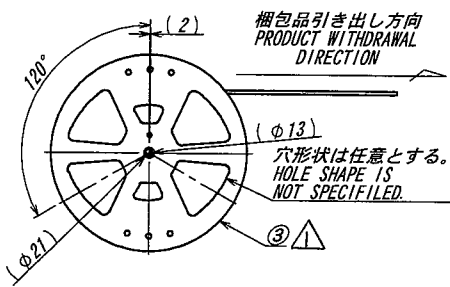
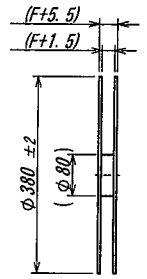
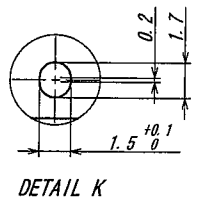
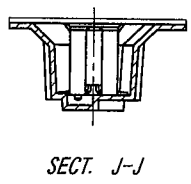
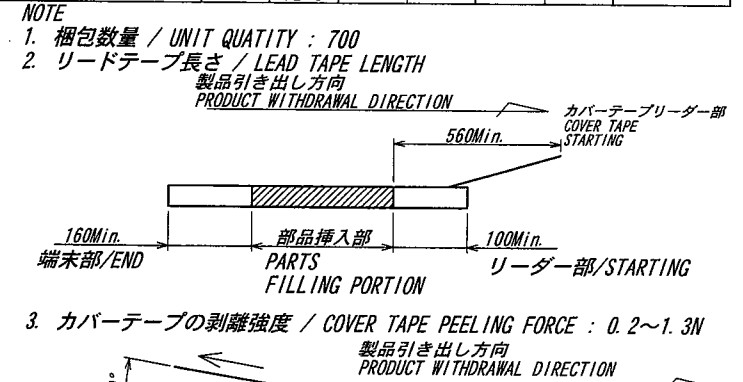
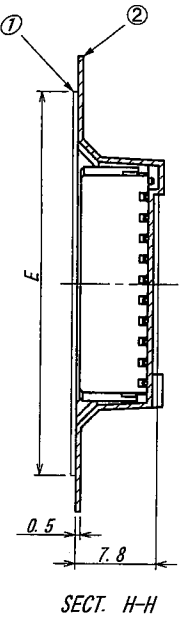

4. テープ幅24mm以下の場合、シングルキャリアとする。(図参照)
TAPE WIDTH UNDER 24mm SINGLE CARRIER
(A DRAWING REFERENCE)

ISSUED '12.2.13
IRISO ENG. DEPT.

MATERIAL 材質		GENERAL TOLERANCES 一般公差		SCALE 尺度	UNIT 単位	TITLE 名称
①カバーテープ/COVER TAPE : PET TYPE ②キャリアテープ/CARRIER TAPE : PS ③リール/REEL : PS(黒/BLACK)		DIM 寸法 ± 0.3 ANGLE 角度 ±		DR '12-2-8 J. Nakayama	mm DSN '11/07/12 H. Kobayashi	9852シリーズ ソケット テーピング 梱包品 SERIES 9852 SOCKET TAPING PRODUCT
FINISH 仕上げ		3RD. ANG. PROJ. 三角法		CHK Y2 S.M. Takagi	APP 2012.2.10 4. Sawaki	BDP No
4108上 ECN No REVISED REVISION RECORD 記 号		I.N M.T DR CHK DATE '12-2-8		IRISO ELECTRONICS CO., LTD イリス電子工業株式会社		PARTS No 部番 9852S-**-Y946
				DWG No 図番		REV. 1
						MSA-9852S-**-Y946

DO NOT SCALE DRAWING.
THIS DRAWING CONTAINS INFORMATION THAT IS PROPRIETARY TO IRISO AND SHOULD NOT BE USED WITHOUT WRITTEN PERMISSION. 本図面は、イリス電子工業(株)の所有する情報を含むもので当社の許可なく複製を禁止する。

REDUCED COPY