

PRODUCT WITHDRAWAL DIRECTION
製品引き出し方向

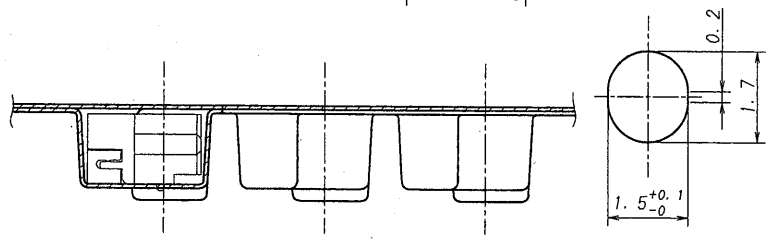
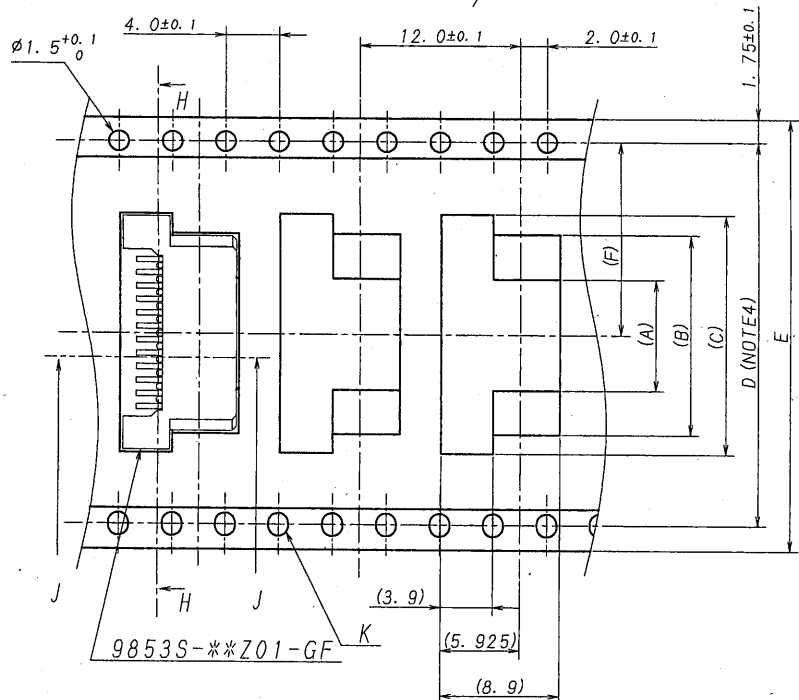

板数/CKT	製品番号/PARTS No.	A	B	C	D	E	F	G
6	9853S-06Y924	2.3	8.9	11.8	/	24	11.5	21.5
8	9853S-08Y924	4.3	10.9	13.8				
10	9853S-10Y924	6.3	12.9	15.8				
12	9853S-12Y924	8.3	14.9	17.8	28.4	32	14.2	26.0
14	9853S-14Y924	10.3	16.9	19.8				
16	9853S-16Y924	12.3	18.9	21.8				
18	9853S-18Y924	14.3	20.9	23.8	40.4	44	20.2	37.0
20	9853S-20Y924	16.3	22.9	25.8				
22	9853S-22Y924	18.3	24.9	27.8				
24	9853S-24Y924	20.3	26.9	29.8	52.4	56	26.2	49.0
26	9853S-26Y924	22.3	28.9	31.8				
28	9853S-28Y924	24.3	30.9	33.8				
30	9853S-30Y924	26.3	32.9	35.8				

NOTE

1. 梱包数量/UNIT QUANTITY: 500
2. リードテープ長さ/LEAD TAPE LENGTH

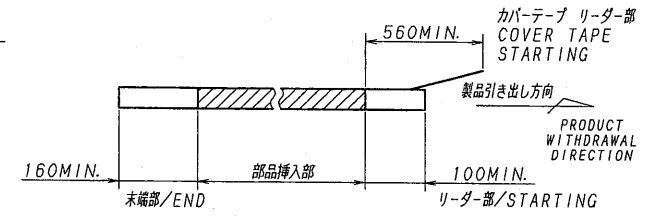

3. カバ-テープの剥離強度/COVER TAPE PEELING FORCE: 0.2~1.3N.

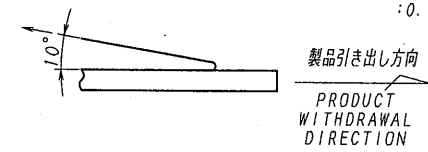

4. テープ幅24mm以下の場合、シングルキャリアとする。(下図参照)
TAPE WIDTH UNDER 24mm SINGLE CARRIER. (SEE CHART BELOW)

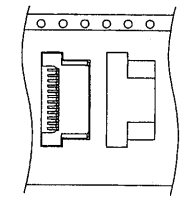

① 1011-***C

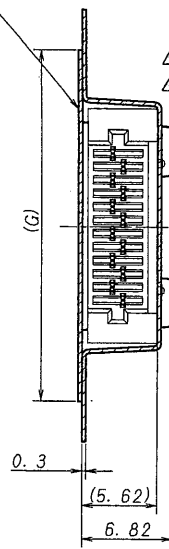

SECT. H-H

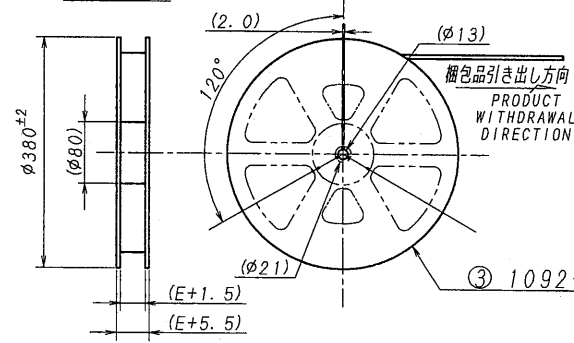

ISSUED
'10.9.-2

IRISO
ENG. DEPT.

MATERIAL 材質			
①	カバ-テープ/COVER TAPE	PET TYPE	
②	キャリアテープ/CARRIER TAPE	A-PET	
③	リール/REEL	PS (黒/BLACK)	
FINISH 仕上り			

GENERAL TOLERANCES 一般公差	
DIM 寸法	± 0.3
ANGLE 角度	±
3RD. ANG. PROJ. 三角法	

SCALE 尺度	UNIT 単位
DR '08-10-1	mm
CHK '08-10-1	
IRISO ELECTRONICS CO., LTD.	
I/I 電子工業株式会社	

TITLE 名称	
9853シリーズ ソケット テーピング 梱包品 SERIES 9853 SOCKET TAPING PRODUCT	
EDP No	
PARTS No 部番	9853S-***Y924
DWG No 図番	IMSA-9853S-***Y924
REV.	4

LTR 記号	ECN NO	REVISION RECORD 記号	DR	CHK	DATE 年月日
△					
△					
△					
△	37844	REVISED	A.O.	M.T.	'10-9-1
△	36220	REVISED	L.Q.	M.T.	'10-1-14
△	35996	REVISED	J.N.	M.T.	'09-12-10
△	33241	Revised	T.H.	M.T.	'08-10-1