

A B C D E F G H

WITHDRAWAL DIRECTION
梱包品引き出し方向

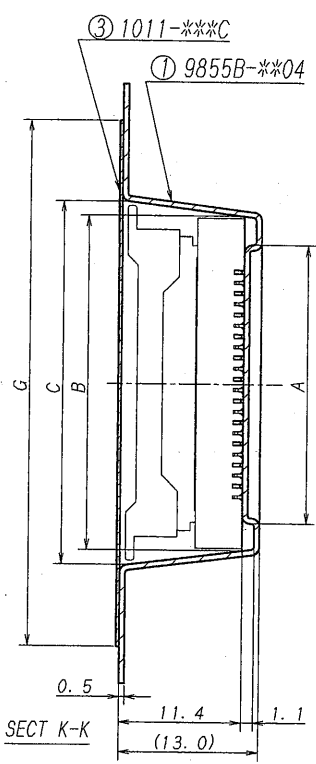
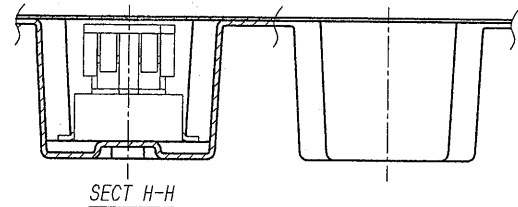
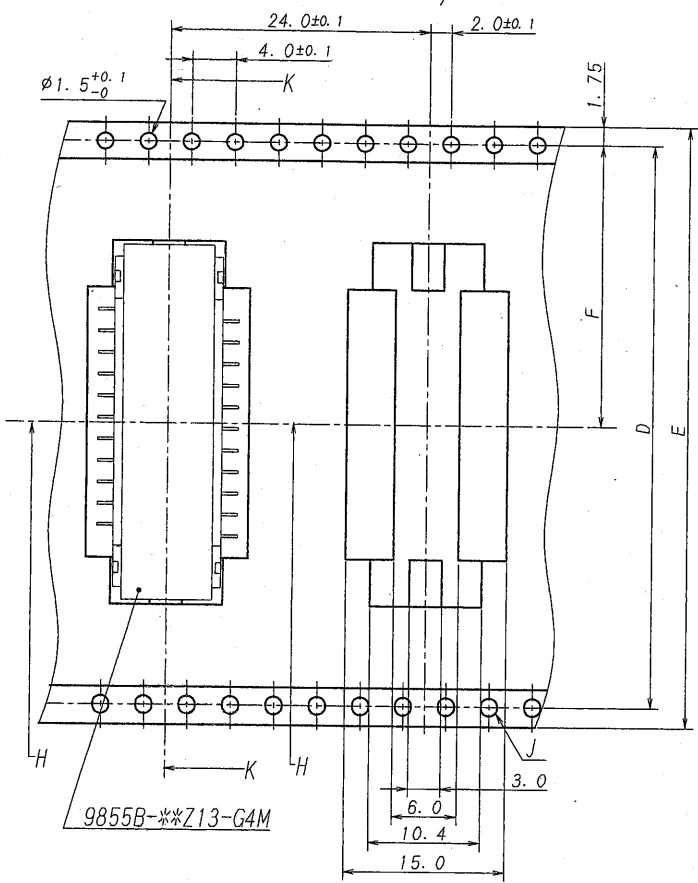

極数/CKT	製品番号/PARTS No.	A	B	C	D	E	F	G
6	9855B-06Y928	10.0	15.1	17.8	28.4	32.0	14.2	26.0
8	-08Y928	12.0	17.1	19.8				
10	-10Y928	14.0	19.1	21.8				
12	-12Y928	16.0	21.1	23.8				
14	-14Y928	18.0	23.1	25.8	40.4	44.0	20.2	37.0
16	-16Y928	20.0	25.1	27.8				
18	-18Y928	22.0	27.1	29.8				
20	-20Y928	24.0	29.1	31.8				
22	-22Y928	26.0	31.1	33.8	52.4	56.0	26.2	49.0
24	-24Y928	28.0	33.1	35.8				
26	-26Y928	30.0	35.1	37.8				
28	-28Y928	32.0	37.1	39.8				
30	9855B-30Y928	34.0	39.1	41.8				

NOTE
 1. 梱包数量/UNIT QUANTITY: 250
 2. リードテープ長さ/LEAD TAPE LENGTH
 3. カバーテープの剥離強度/COVER TAPE PEELING FORCE : 0.2~1.3N.

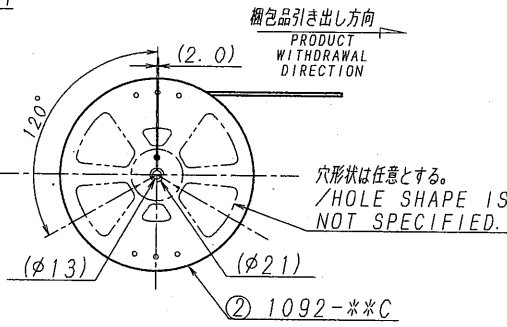
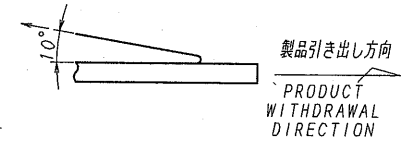
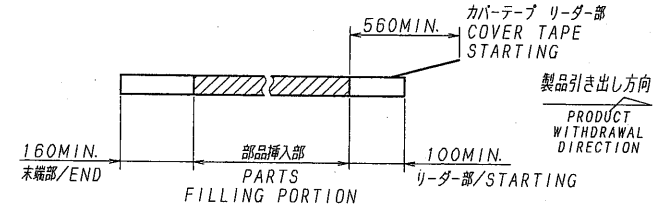
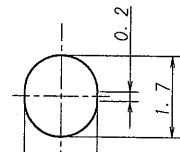

ISSUED
 '10.3.24
 IRISO
 ENG. DEPT.

MATERIAL 材質					GENERAL TOLERANCES 一般公差		SCALE 尺度		UNIT 単位		TITLE 名称	
① キャリヤテープ/CARRIER TAPE: PS					DIM 寸法 ±0.3		DR '10-3-12		mm		SERIES 9855 PLUG TAPING PRODUCT	
② リール/REEL : PS (黒/BLACK)					ANGLE 角度 ±		CHK '10.3.12		DSN '10-2-17		9855シリーズ プラグ テーピング梱包品	
③ カバーテープ/COVER TAPE: PET TYPE					3RD. ANG. PROJ. 三角法		APP '10.3.12		EDP No		PARTS No 部番	
FINISH 仕上げ					IRISO ELECTRONICS CO., LTD.		8. Mitsunaga		REV.		9855B-***Y928	
DO NOT SCALE DRAWING.					IRISO 電子工業株式会社		IMSA-9855B-***Y928		REV. 0		9855B-***Y928	