

製品引き出し方向  
PRODUCT WITHDRAWAL DIRECTION

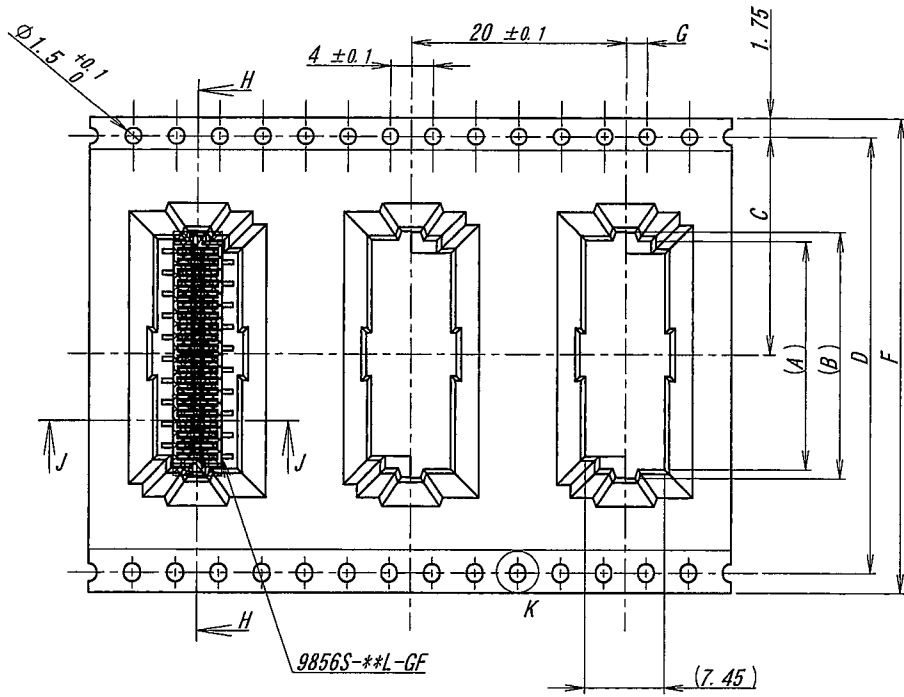

極数/CKT	製品番号/PARTS No.	A	B	C	D	E	F	G
10	9856S-10Y958	11.2	12.8	14.2	28.4	26	32	2.0 ± 0.15
12	9856S-12Y958	13.2	14.8					
14	9856S-14Y958	15.2	16.8					
16	9856S-16Y958	17.2	18.8					
18	9856S-18Y958	19.2	20.8	20.2	40.4	37	44	
20	9856S-20Y958	21.2	22.8					
22	9856S-22Y958	23.2	24.8					
24	9856S-24Y958	25.2	26.8					
26	9856S-26Y958	27.2	28.8	26.2	52.4	49	56	
28	9856S-28Y958	29.2	30.8					
30	9856S-30Y958	31.2	32.8					

NOTE  
1. 梱包数量/UNIT QUANTITY: 300  
2. リードテープ長さ/LEAD TAPE LENGTH

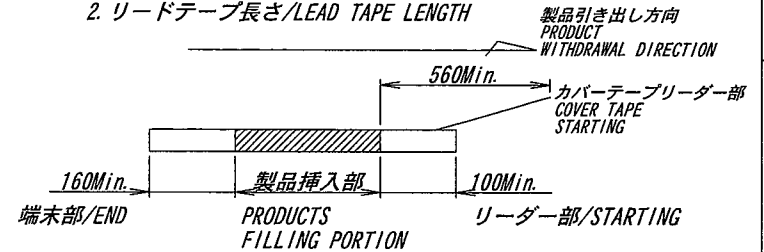

3. カバーテープの剥離強度/COVER TAPE PEELING FORCE  
0.2N~1.3N

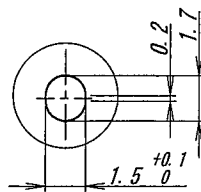
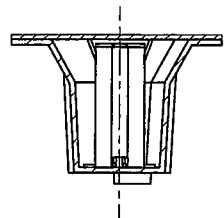
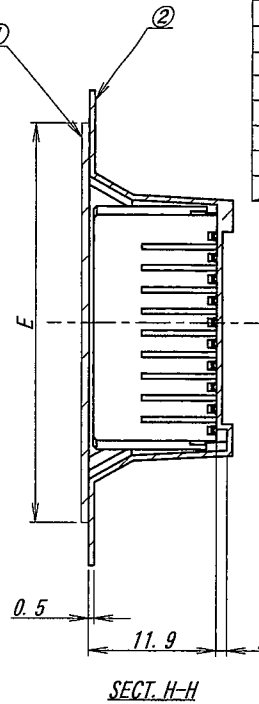

DETAIL K

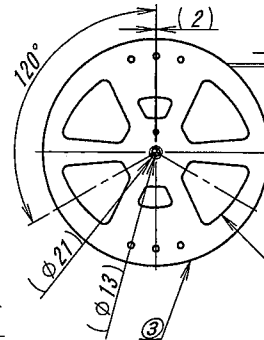
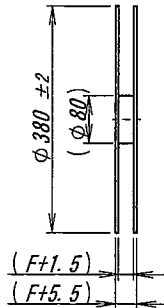

製品引き出し方向  
PRODUCT WITHDRAWAL DIRECTION

穴形状は任意とする。  
HOLE SHAPE IS NOT SPECIFIED.

ISSUED  
14.5.30  
IRISO  
ENG. DEPT.

△					
△					
△					
△					
△					
△	4785/	NOTE REV	L. Q	M. T	'14-5-29
△	43718	REVISED	T. H	M. T	'12-10-29
△	41498	RELEASED	L. Q	M. T	'12-4-26
△	ECN No	REVISION RECORD	DR	CHK	DATE

MATERIAL 材質	①カバーテープ/COVER TAPE : PET TYPE ②キャリアテープ/CARRIER TAPE : PS ③リール/REEL : PS (黒/BLACK)
FINISH 仕上げ	

GENERAL TOLERANCES 一般公差	DIM 寸法 ± 0.3 ANGLE 角度 ±
3RD. ANG. PROJ. 三角法	

SCALE 尺度	UNIT 単位
DR '14-5-29 Lin. Qi	mm DSN '12-4-26 Lin. Qi
CHK >4 S. Takagi	APP M. Tsubota
IRISO ELECTRONICS CO., LTD イリソ電子工業株式会社	

TITLE 名称	9856シリーズソケットエンボス梱包品 SERIES 9856 SOCKET EMBOSS PRODUCT
BDP No	
PARTS No 部番	IRISA-9856S-**Y958
DWG No 図番	120-109856-012
REV.	2