

A B C D E F G H

引き出し方向
WITHDRAWAL DIRECTION

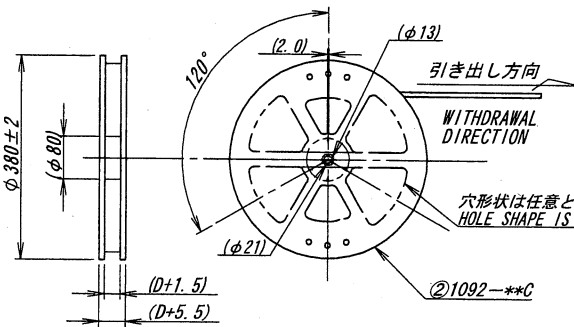
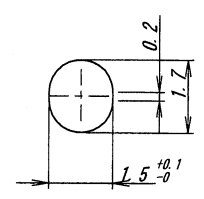
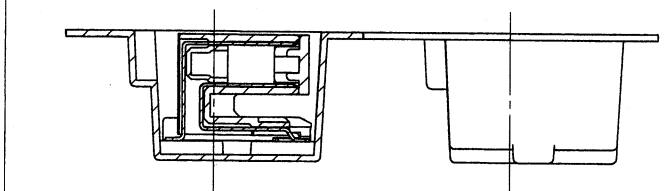
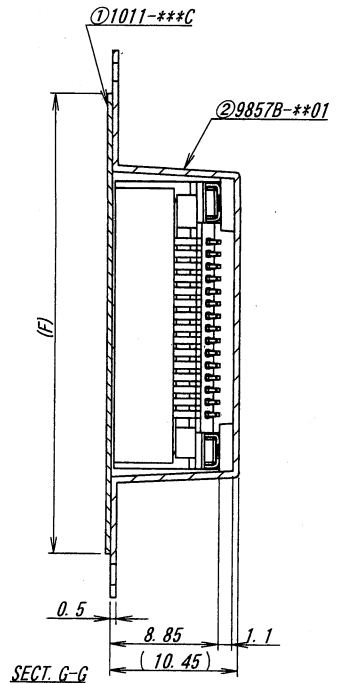
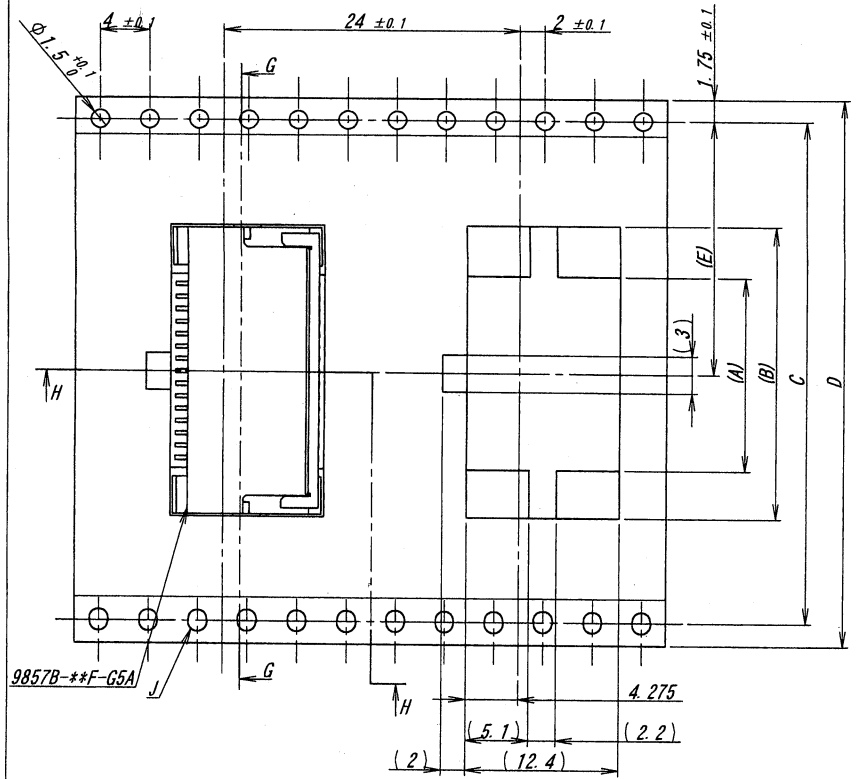

種数/OKT	部品番号/PARTS No.	A	B	C	D	E	F
8	9857B-08Y905	4.6	12.4				
12	9857B-12Y905	6.6	14.4		24.0	11.5	21.5
16	9857B-16Y905	8.6	16.4				
20	9857B-20Y905	10.6	18.4		28.4	32.0	14.2
24	9857B-24Y905	12.6	20.4				26.0
28	9857B-28Y905	14.6	22.4				
32	9857B-32Y905	16.6	24.4				
36	9857B-36Y905	18.6	26.4				
40	9857B-40Y905	20.6	28.4		40.4	44.0	20.2
44	9857B-44Y905	22.6	30.4				37.0
48	9857B-48Y905	24.6	32.4				
52	9857B-52Y905	26.6	34.4	52.4	56.0	26.2	49.0

NOTE

1. 梱包数量/UNIT QUANTITY: 350
2. リードテープ長さ/LEAD TAPE LENGHT

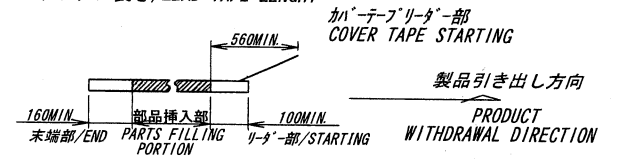

3. カバーテープの剥離強度/COVER TAPE PEELING FORCE : 0.2N~1.3N

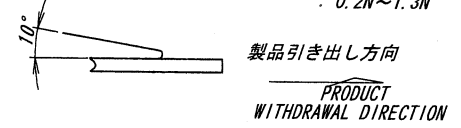

4. テープ幅24mm以下の場合、シングルキャリアとする。 TAPE WIDTH UNDER 24mm SINGLE CARRIER. (SEE BELOW)

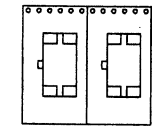

ISSUED
'10.10.19
IRISO
ENG. DEPT.

SECT. H-H

DETAIL J

MATERIAL 材質		GENERAL TOLERANCES 一般公差		SCALE 尺度	UNIT 単位	TITLE 名称
①カバーテープ/COVER TAPE : PET TYPE		DIM 寸法 ± 0.3		DR '10-10-18	mm	SERIES 9857 PLUG ENBOSS TAPING PRODUCT 9857 シリーズ プラグ テーピング梱包品
②キャリアテープ/CARRIER TAPE : PS		ANGLE 角度 ±		Y. Kitagawa	'07-2-22	
③リール/REEL : PS (黒/BLACK)		3RD. ANG. PROJ. 三角法		CHK Y.S.	T. Takane	BDP No
FINISH 仕上げ				18M TAKAGI		PARTS No 部番
				U. Nakahara		9857B-**Y905
DO NOT SCALE DRAWING				IRISO ELECTRONICS CO., LTD		DWG No 図番
THIS DRAWING CONTAINS INFORMATION THAT IS PROPRIETARY TO IRISO AND SHOULD NOT BE USED WITHOUT WRITTEN PERMISSION.				IIY電子工業株式会社		REV. 0
						1MSA-9857B-**Y905