

A B C D E F G H

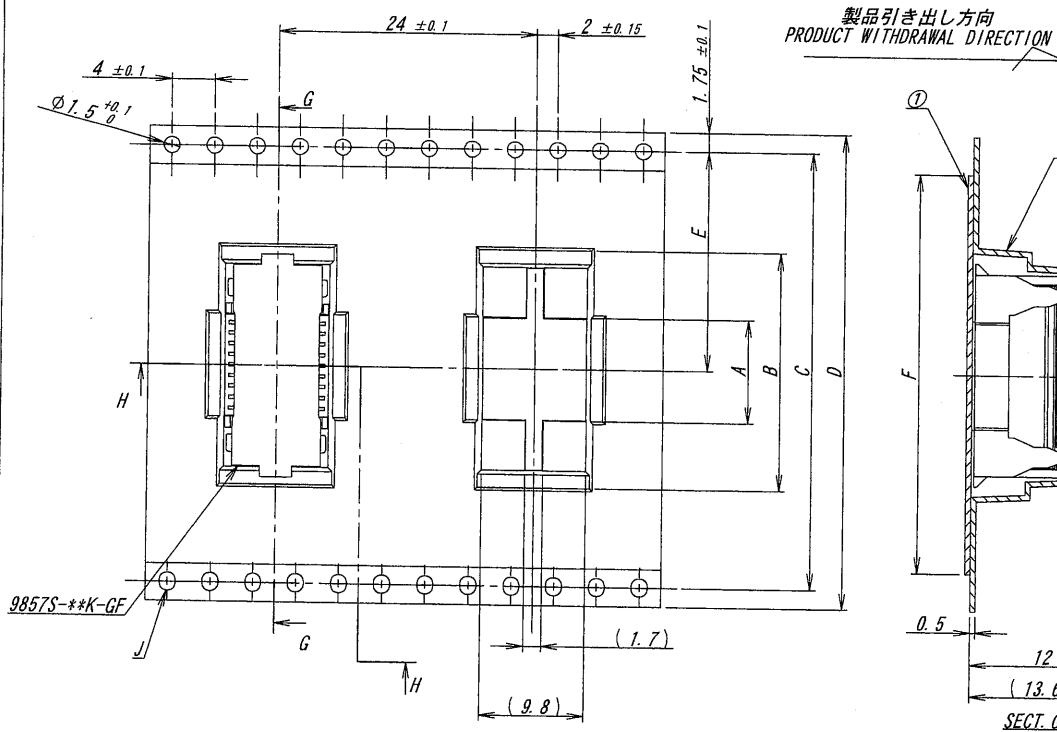

極数/CKT	部品番号/PARTS No.	A	B	C	D	E	F
18	9857S-18Y913	9.6	22.0	40.4	44.0	20.2	37.0
20	9857S-20Y913	10.6	23.0	40.4	44.0	20.2	37.0

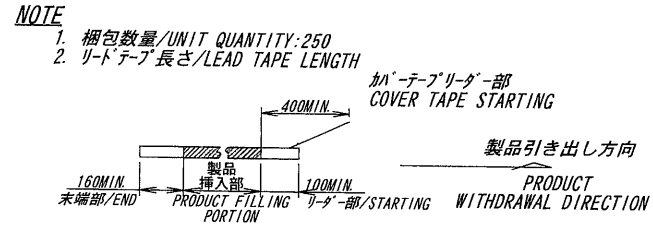
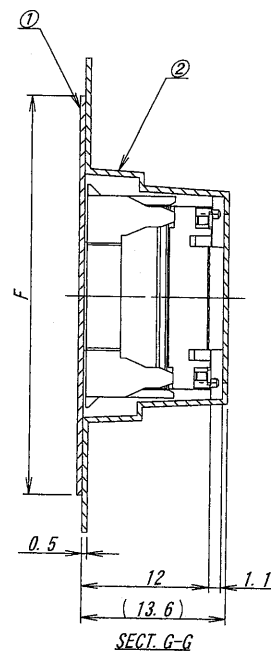

3. 加-テープの剥離強度/COVER TAPE PEELING FORCE : 0.2N~1.3N

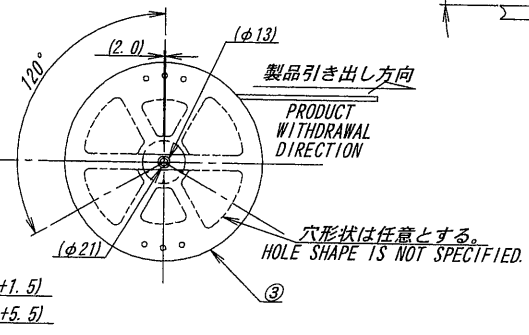
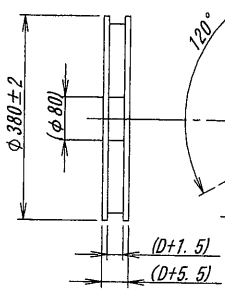
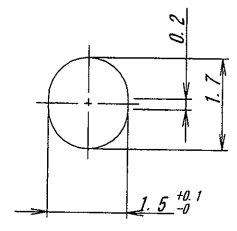
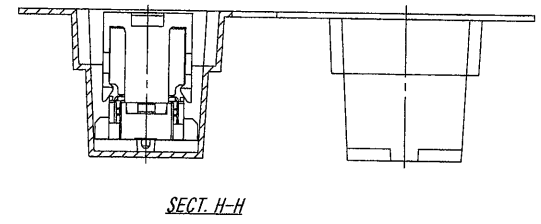
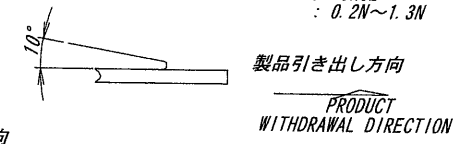

**ISSUED**  
13.5.24  
IRISO  
ENG. DEPT.

△ △ △ △ △ △ △ △	MATERIAL 材質				GENERAL TOLERANCES 一般公差 DIM 寸法 ± 0.3 ANGLE 角度 ± 3RD. ANG. PROJ. 三角法	SCALE 尺度	UNIT 単位	TITLE 名称 SERIES 9857 SOCKET EMBOSS PRODUCT 9857 シリーズ ソケット エンボス 梱包品 EDP No PARTS No 部番 DWG No 図番	
	①加-テープ/COVER TAPE : PET TYPE ②キャリアテープ/CARRIER TAPE : PS ③リール/REEL : PS (黒/BLACK)					DR 13-05-16 D. Kim	mm		DSN 09-06-04 K. Ito
	FINISH 仕上げ					CHK 13 5/21 K. Kobayashi			APP 13 5/1 M. Takagi
	44097 RELEASED D.K. K.K. 13-05-16 LTR ECH No REVISION RECORD 記 DR CHK DATE 年月日					IRISO ELECTRONICS CO., LTD イリソ電子工業株式会社			
PARTS No 部番 <b>1MSA-9857S-**Y913</b>									
DWG No 図番 <b>120-109857-010</b>									
REV. 0									

DO NOT SCALE DRAWING. THIS DRAWING CONTAINS INFORMATION THAT IS PROPRIETARY TO IRISO AND SHOULD NOT BE USED WITHOUT WRITTEN PERMISSION. 本図面は、イリソ電子工業(株)の所有する情報を含むもので当社の許可なく複製を禁じます。