

製品引き出し方向
PRODUCT WITHDRAWAL DIRECTION

極数/CKT	部品番号/PARTS No.	A	B	C	D	E	F
18	9857S-18Y914	9.6	22.0	40.4	44.0	20.2	37.0
20	9857S-20Y914	10.6	23.0	40.4	44.0	20.2	37.0

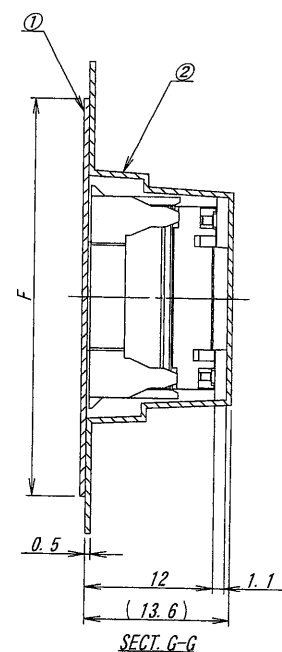

NOTE

- 梱包数量/UNIT QUANTITY: 250
- リードテープ長さ/LEAD TAPE LENGTH

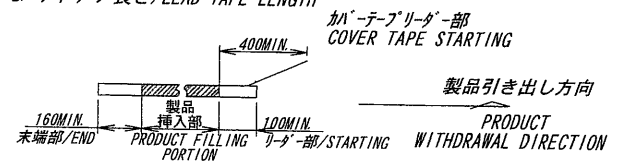

- カバーテープの剥離強度/COVER TAPE PEELING FORCE : 0.2N~1.3N

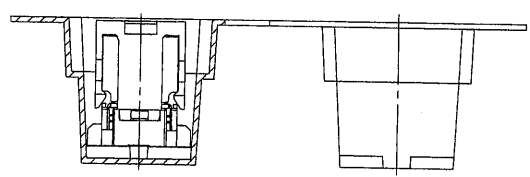
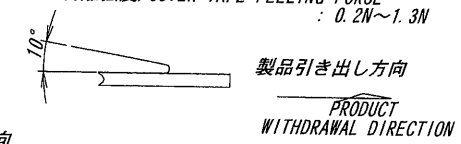

SECT. H-H

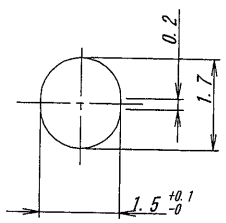

DETAIL J

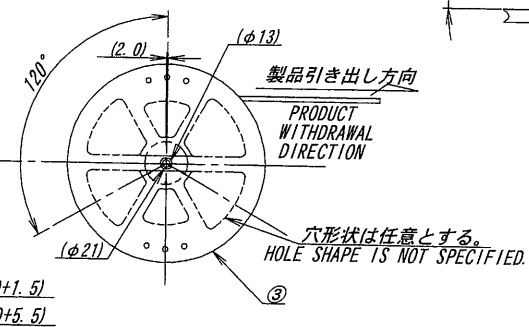
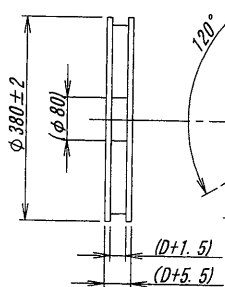

ISSUED
13.5.24
IRISO
ENG. DEPT.

△					
△					
△					
△					
△					
△					
△	44097	RELEASED	D.K	K.Y	13-05-16
△	ECN No.	REVISION RECORD	DR	CHK	DATE
△	記号	記号	記号	記号	年月日

MATERIAL 材質
 ①カバーテープ/COVER TAPE : PET TYPE
 ②キャリアテープ/CARRIER TAPE : PS
 ③リール/REEL : PS (黒/BLACK)
 FINISH 仕上げ

GENERAL TOLERANCES 一般公差
 DIM 寸法 ± 0.3
 ANGLE 角度 ±

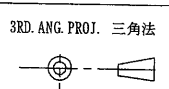

SCALE 尺度 / UNIT 単位 mm
 DR 13-05-16 DSN 09-06-04
 D. Kim K. Ito
 CHK 13 APP 13
 5/21 K. Kobayashi S. Yamaguchi
 IRISO ELECTRONICS CO., LTD
 伊電子工業株式会社

TITLE 名称
 SERIES 9857 SOCKET EMBOSS PRODUCT
 9857 シリーズ ソケット エンボス梱包品
 EDP No
 PARTS No 部番
 IMSA-9857S-**-Y914
 DWG No 図番
 120-109857-011
 REV. 0