

A B C D E F G H

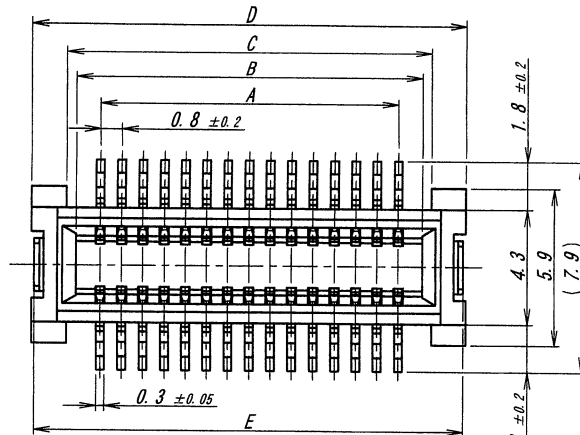

極数/CKT	部品番号/PARTS No.	A	B	C	D	E	NOTE
30	9860B-30Z15-GFA	11.2	13.0	13.7	16.3	16.1	
40	9860B-40Z15-GFA	15.2	17.0	17.7	20.3	20.1	
50	9860B-50Z15-GFA	19.2	21.0	21.7	24.3	24.1	
60	9860B-60Z15-GFA	23.2	25.0	25.7	28.3	28.1	
70	9860B-70Z15-GFA	27.2	29.0	29.7	32.3	32.1	
80	9860B-80Z15-GFA	31.2	33.0	33.7	36.3	36.1	
90	9860B-90Z15-GFA	35.2	37.0	37.7	40.3	40.1	
100	9860B-100Z15-GFA	39.2	41.0	41.7	44.3	44.1	
110	9860B-110Z15-GFA	43.2	45.0	45.7	48.3	48.1	
120	9860B-120Z15-GFA	47.2	49.0	49.7	52.3	52.1	

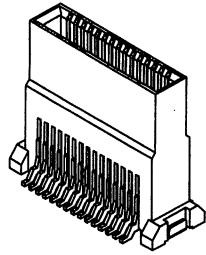
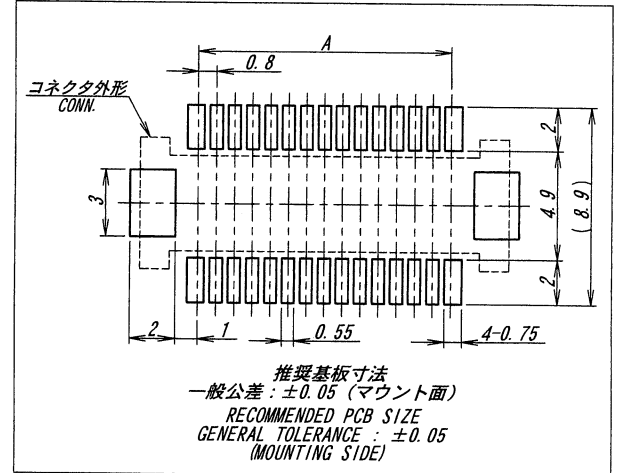
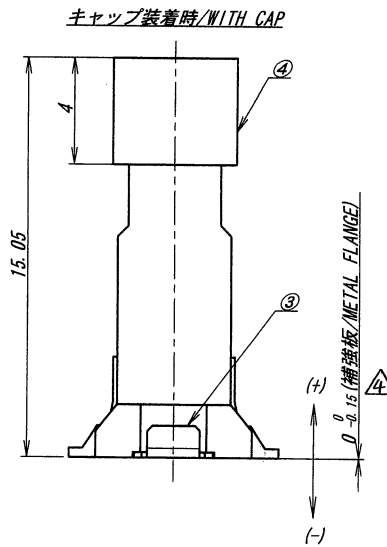
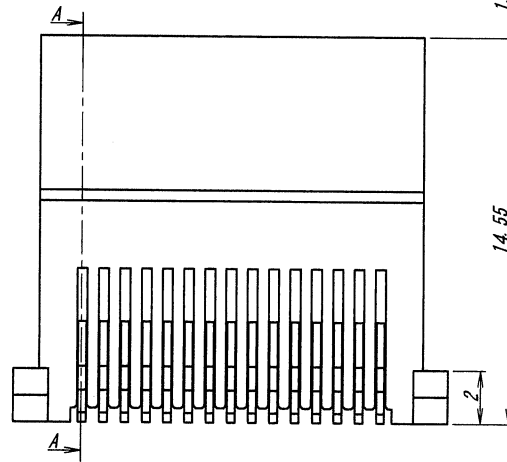
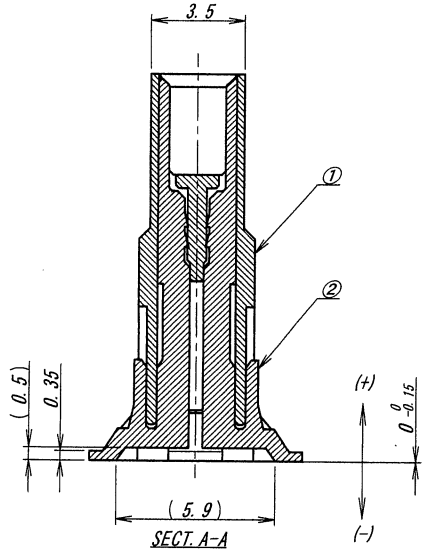

NOTE
1. コプラナリティ/COPLANARITY : 0.1MAX.

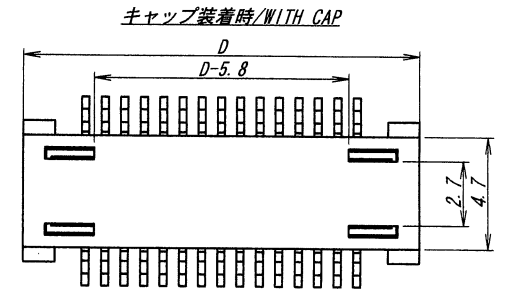

ISSUED
'13.3.11
IRISO
ENG. DEPT

TR 記号	BCN No	REVISION RECORD 記	DR	CHK	DATE 年月日
△					
△					
△					
△	43560	NOTE REV	Y. S	T. A	'13-3-4
△	42636	REVISED	T. N	M. T	'12-11-9
△	41257	NOTE REV	Y. K	M. T	'12-3-16
△	38515	NOTE REV	S. Y	M. T	'10-12-9
△	29062	RELEASED	S. M	T. U	'07-4-19

MATERIAL 材質
①ベース/BASE: ガラス入り46ナイロン/GLASS FILLED 46 NYLON 自然色/NATURAL UL94V-0
②ポスト/POST: 黄銅/BRASS (t=0.3)
③補強板/METAL FLANGE: 黄銅/BRASS (t=0.2)
④キャップ/CAP: ガラス入り46ナイロン/GLASS FILLED 46 NYLON 黒色/BLACK UL94V-0

FINISH 仕上げ
①ポスト/POST: ニッケル下地めっき/OVER Ni PLATE: 2μMIN. 金めっき (鍍金) /Au PLATE (CONTACT POINT): 0.1μMIN. (フェール部) /SOLDER TAIL: 0.03μMIN.
③補強板/METAL FLANGE: ニッケル下地めっき/OVER Ni PLATE: 1~3μ. スズめっき/TIN-COPPER PLATE: 2~5μ.

GENERAL TOLERANCES 一般公差
DIM 寸法 ± 0.3
ANGLE 角度 ±

3RD. ANG. PROJ. 三角法

SCALE 単位 mm
DR '13-3-4 Y. Suzuki
CHK '13-3-7 J. Abe

UNIT 単位 mm
DSN '04-10-15 H. Honma
APP 7/3 3/7 M. Takagi

IRISO ELECTRONICS CO., LTD
IIV電子工業株式会社

TITLE 名称
9860シリーズ プラグ
SERIES 9860 PLUG

EDP No

PARTS No 部番
9860B-**Z15-GFA

DWG No 図番
IMSA-9860B-**Z15-GFA

REV. 4