

NOTE :

- 1. 梱包数量/UNIT QUANTITY : 300 PIECES/REEL
- 2. リードテープ長さ/LEAD TAPE LENGTH
 リーダー部(空部) LEADER (EMPTY) 100 MIN.

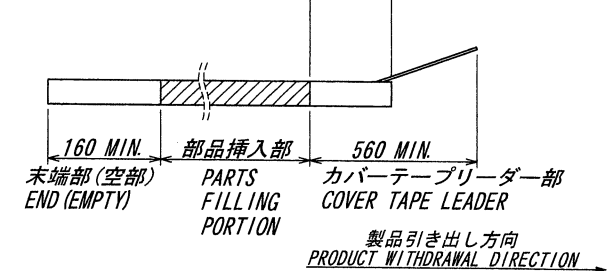

- 3. カバーテープの剥離強度 : 0.2~1.3N
 COVER TAPE PEELING FORCE : 0.2~1.3N
 剥離方向は、下図参照
 PEELING DIRECTION AS BELOW

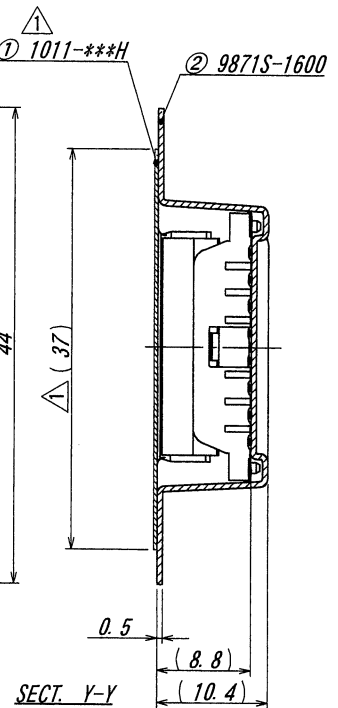
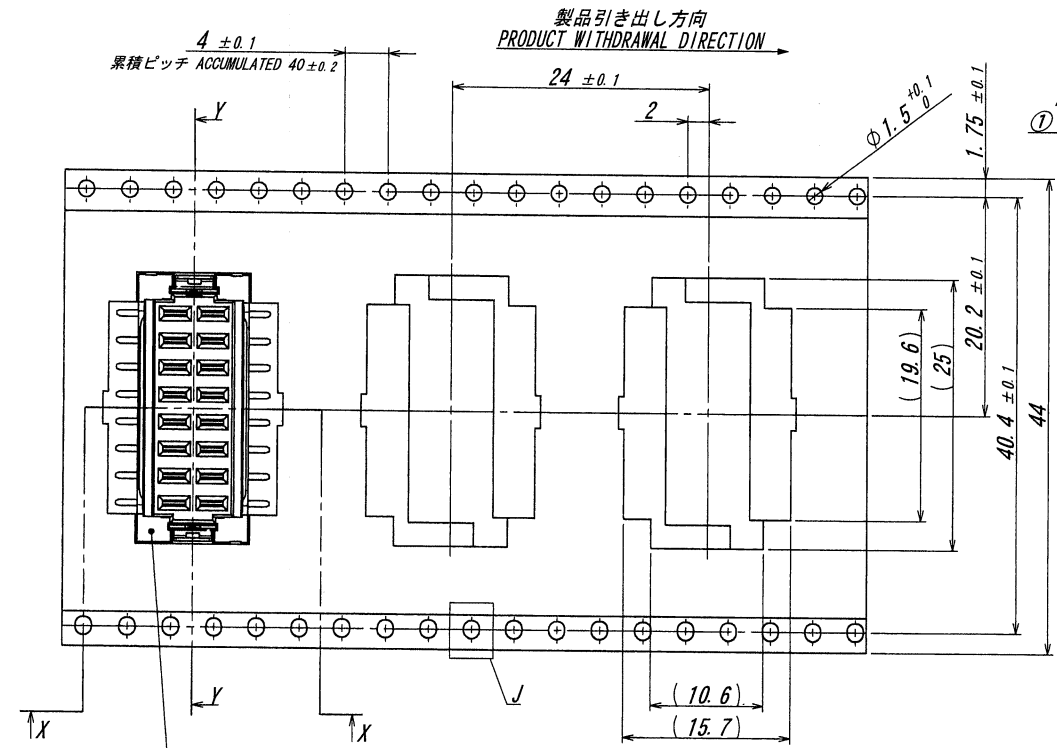
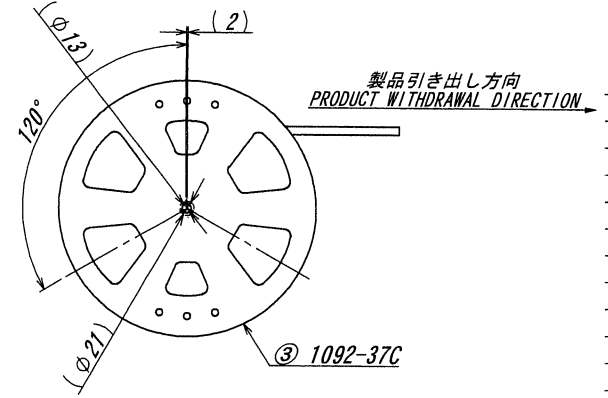
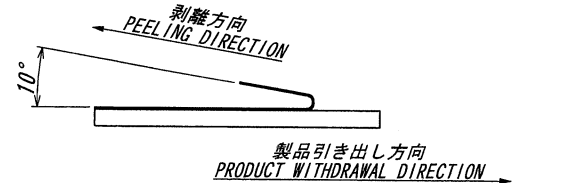

9871S-16A-GFN1

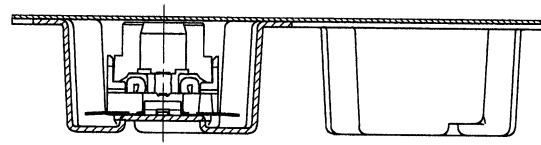

SECT. X-X

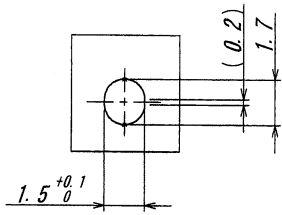

DETAIL "J"

ISSUED
11.11.28
IRISO
ENG. DEPT.

MATERIAL 材質					GENERAL TOLERANCES 一般公差		SCALE 尺度		UNIT 単位		TITLE 名称	
①カバーテープ/COVER TAPE : PET TYPE					DIM 寸法 ± 0.3		DR '11-11-17		DSN '09-08-25		9871シリーズ ソケット エンボス梱包品	
②キャリアテープ/CARRIER TAPE : PS, CLEAR					ANGLE 角度 ±		T. YASUI		T. YASUI		SERIES 9871 SOCKET EMBOSS PACKAGING	
③リール/REEL : PS, BLACK					3RD. ANG. PROJ. 三角法		CHK '11-11-17		APP T. Sakamoto		EPP No	
FINISH 仕上げ							IRISO ELECTRONICS CO., LTD		IRISO 電子工業株式会社		PARTS No 部番	
40650 REVISED T. Y. '11.11.17											9871S-16Y900	
RELEASED T. Y. '09.8.25											DWG No 図番	
LTK 記号											120-109871-001	
BCN No											REV. 1	